

RLP 100 F903, F908: Pneumatic volume-flow transducer

Used in conjunction with an orifice plate or a dynamic pressure sensor for registering the actual value of the air volume, e.g. the output signal of the transducer in the exhaust air is used as the command variable of a volume-flow controller in the supply air. All the listed VAV transducers comply with EN 13463-1 and EN 1127-1 (Ex II 2 G T6) and can be employed in Zone 1 areas where there is a risk of explosion.

Baseplate of glass-fibre-reinforced thermoplastic with high-sensitivity measuring diaphragm; snap-on lid; front plate with the adjusters for influence and setpoint shift; suitable for mounting vertically into panels or onto walls; rail C-EN 50024 and fixing bracket (accessory). Compressed-air connection Rp 1/8 with female thread. Low-pressure connections: 2 stepped push-on connectors for soft plastic tubing (internal dia. 4 and 6 mm).



T03155

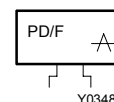

Type	Description	Measuring range		Weight [kg]
		Air volume [% \dot{V}]	Pressure difference ¹⁾ [Pa]	
RLP 100 F903	–	10...100	1.6...160	0.6
RLP 100 F908	for aggressive gases	10...100	1.6...160	0.6
Output pressure	0.1...1.0 bar	Response sensitivity	0.1 Pa	
Input: setpoint shift $\Delta \dot{V}$	3...20% \dot{V}	Linearity, square-root error		
Usable range p_{stat}	0...3000 Pa	between 20...100% \dot{V}	2% of \dot{V}_{100}	
Permissible pressure (low-pressure connections)	3000 Pa	between 10...20% \dot{V}	4% of \dot{V}_{100}	
Supply pressure ²⁾	1,3 bar \pm 0,1	Permissible amb. temp.	0...55 °C	
Air capacity	320 l _n /h	Connection diagram	A02884	
Air consumption	38 l _n /h	Dimension drawing	M297570	
Degree of protection	IP 30	Fitting instructions	MV 505019	

Accessories

0297354 000* Short screw-type connector (Rp 1/8) for soft plastic tubing, internal \varnothing 4 mm; 3 pcs required

0297762 001 Restrictor \varnothing 0.8 mm for attenuating turbulent low-pressure signals; 2 pcs required

0274571 000 Restrictor \varnothing 0.5 mm for attenuating turbulent low-pressure signals; 2 pcs required

0297870 001* Fixing bracket for fitting the controller to ceilings, floors or panels.

^{*)} Dimension drawing or wiring diagram are available under the same number

1) Factory setting (E = 1.8); using the adjuster E, this can be reduced to 1...25 Pa (E = 0.7).

2) See Section 60 on regulations concerning the quality of supply air, especially at low ambient temperatures.

Operation

The pressure difference (1.6...160 Pa) created at the orifice plate or dynamic pressure sensor is converted by the root-extracting transducer into a fluidic-linear standard signal (0.1...1.0 bar). The standard signal is proportionate to the air volume or air speed. A de-coupling amplifier is incorporated to de-couple the measuring system from the output signal.

The measuring range for the pressure difference is set via adjuster E. When E = 1.8, the range is 1.6...160 Pa (factory setting); when E = 1.4 the range is 1...100 Pa (evaluative output pressure 0.2...1.0 bar, measurable air volume 20...100%). When E = 0.7, the range is only 1...25 Pa because pressure differences smaller than 1 Pa cannot be measured (evaluative output pressure 0.2...1.0 bar, measurable air volume 20...100%).

The transducer's output signal can be reduced by 3...20% \dot{V} at the $\Delta \dot{V}$ adjuster. Therefore, the controller is given the false impression of a lower air volume. A difference arises between the supply- and the exhaust-air volumes, causing over- or under-pressure in the room (as long as the supply-air controller is fitted with an $\Delta \dot{V}$ adjuster). The output signal can be adjusted externally via terminal 8; the value set at the $\Delta \dot{V}$ adjuster becomes the minimum limitation.

Additional function for RLP 100 F908

In order to protect the measuring diaphragm from aggressive gases, a very small amount of air is fed constantly into the '+' and '-' low-pressure line.

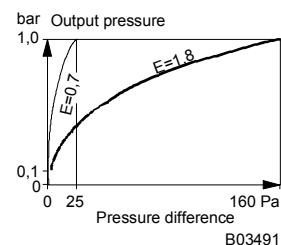

B03491

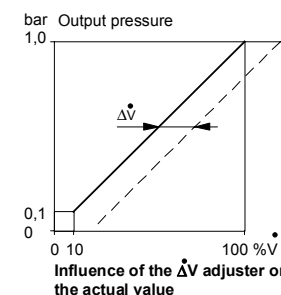

B03492

Engineering and fitting notes

The unit should not be fitted laterally (as depicted below, right).

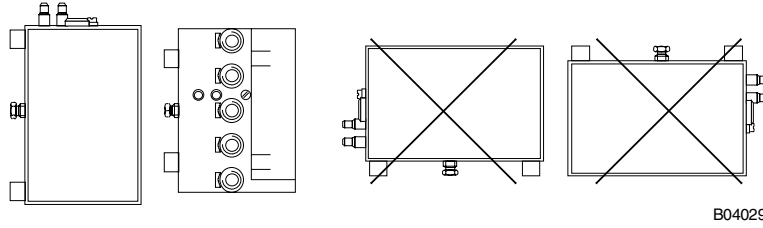

B04029

In order to prevent turbulence which, in the form of oscillations, affects the low-pressure signal, there should be a smoothing sector in front of the measuring cross for the measurement of differential pressure.

Where the flow may be problematical – e.g. right-angles, bends or junctions directly in front of the measuring cross –, a restrictor should be fitted into the plastic tubing of the ‘+ and –’ connection in order to attenuate turbulent low-pressure signals.

Technical information

Technical manual: VAV 7 000 621 003

Additional information on accessories

0297762 001 Restrictor (Ø 0.8 mm) for damping turbulent low-pressure signals; push-on connector for soft plastic tubing of Ø 4 mm internal. If the damping is insufficient, a Ø 0.5 mm restrictor can be used instead (accessory no. 0274571; not suitable for RLP 100 F908, F914, F123).

0274571 000 Restrictor (Ø 0.5 mm) for damping turbulent low-pressure signals; push-on connector for soft plastic tubing of Ø 4 mm internal. Used in extreme cases where the Ø 0.8 mm restrictor has proved to be inadequate. Unsuitable for any volume-flow controllers (RLP 100 F914 and F123) and transducers (RLP 100 F908) that have a very small amount of air fed constantly into the ‘+ and –’ low-pressure line, since the pressure signals in the lower part of the measuring range are falsified, and the positioning time of 1...2 seconds (RLP 100 F123) is not attained.

Connection diagram

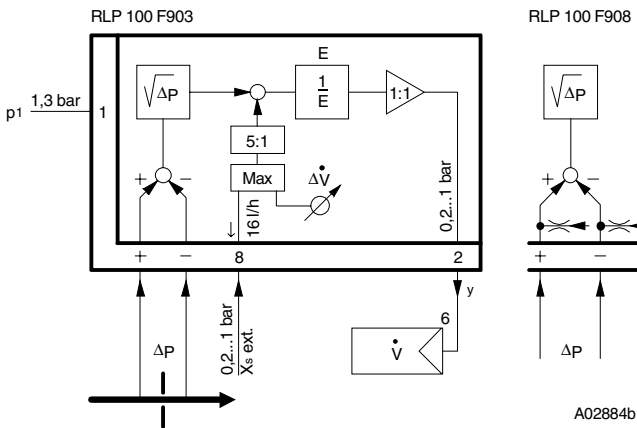

Δp = pressure difference
 y = output pressure

Dimension drawing

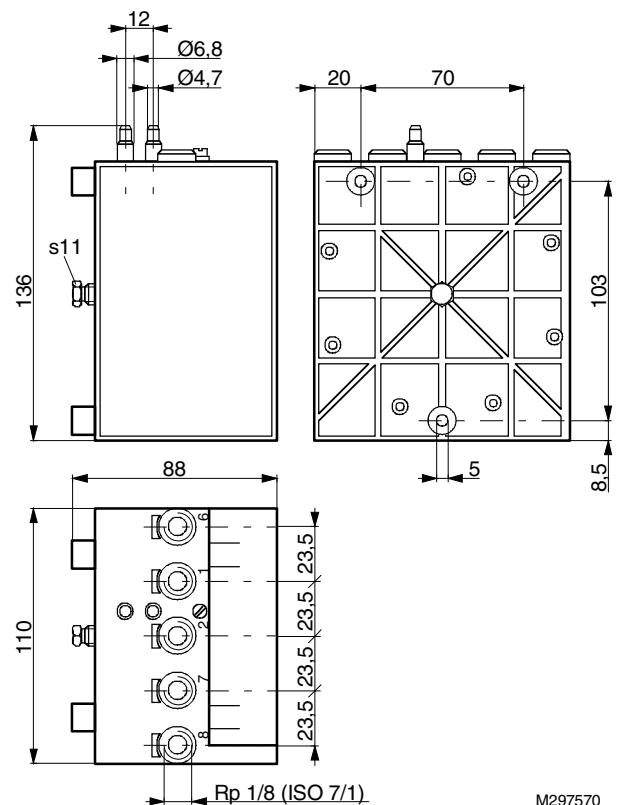

Accessories

297354

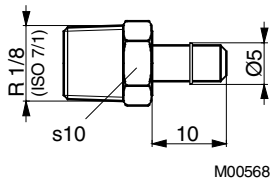

297870 001

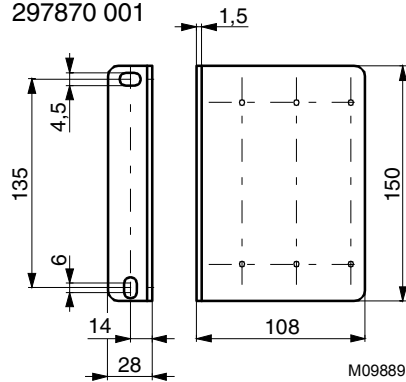

Example of use

Volume of return air controlled in proportion to the amount that the fume cupboard's sash is opened, with VAV transducer, for aggressive gases.

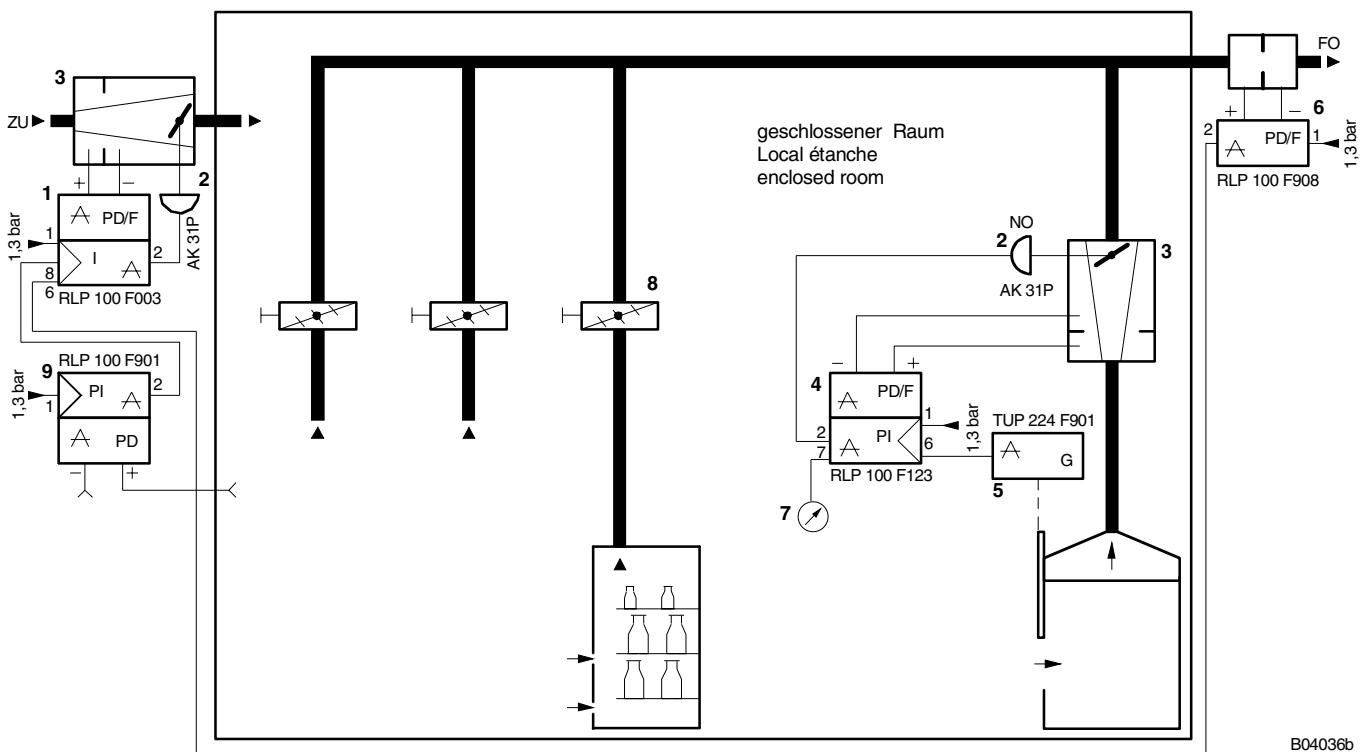

B04036b

1	Volume-flow controller	7	Manometer, 0297797
2	Damper drive NO	8	Manual damper
3	Pressure-release unit	9	Pressure controller
4	VAV return-air controller for fume cupboards	FO	EA (exhaust air)
5	Path-measuring transmitter	ZU	SA (supply air)
6	Volume-flow transducer for aggressive gases	NO =	normally open